

INSTALLATION GUIDE

SURFACE MOUNT

CODE: LLF0606SM

To suit LED Ceiling Panels

Panel size: 595mm x 595mm

Frame size: 609mm x 609mm x 48mm

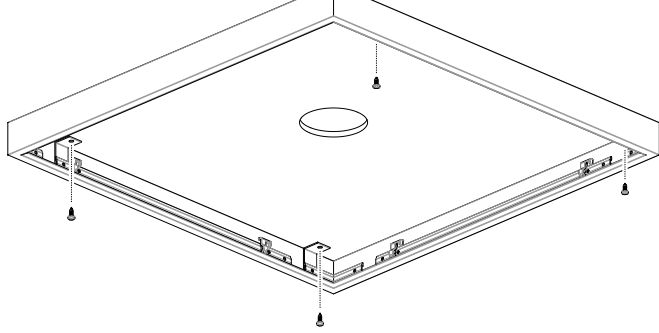

1. Fix frame to ceiling in desired location using appropriate fixings suitable for the ceiling material.

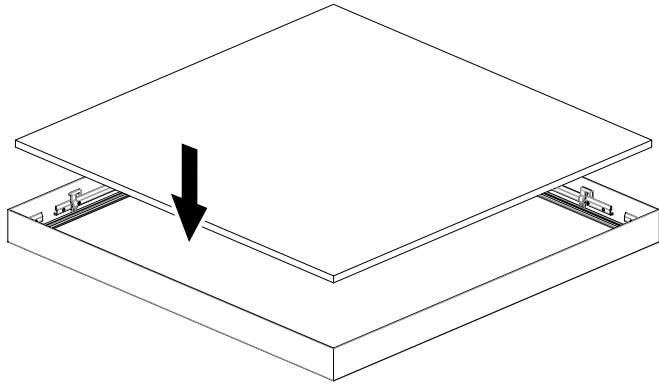

3. Assemble LED light panel into the frame.

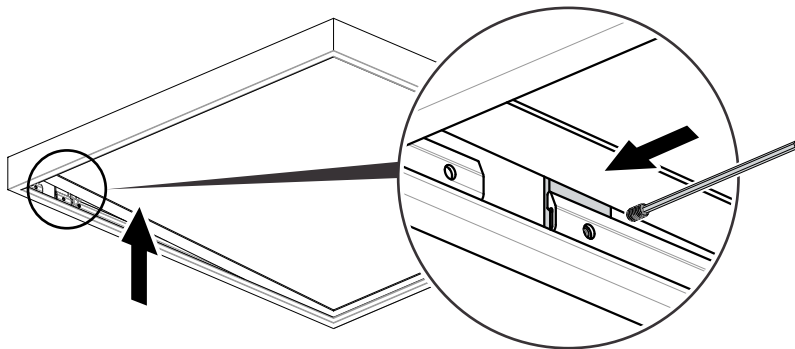

5. Tilt LED light panel and ensure frame is aligned with the surface mount hangers, then secure frame to the hangers with grub screws.

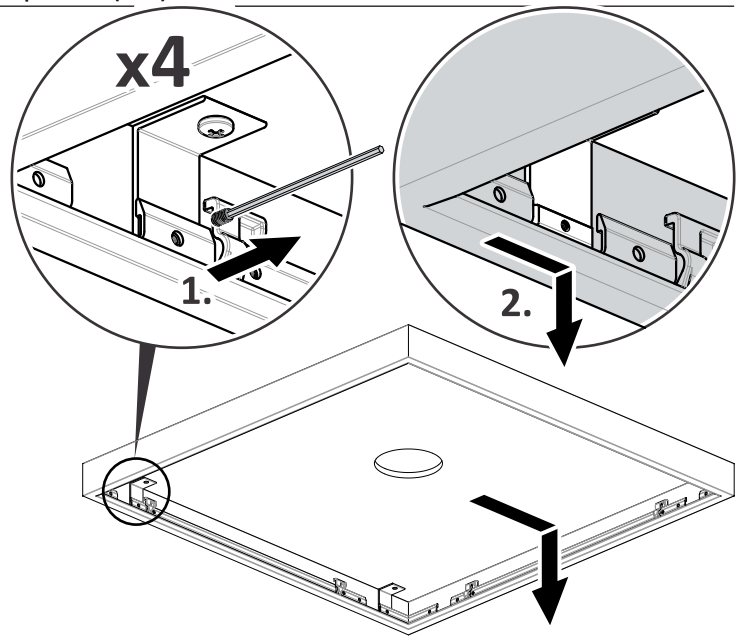

2. Undo grub screws that hold frame to the surface mount hangers and slide frame across and down to remove.

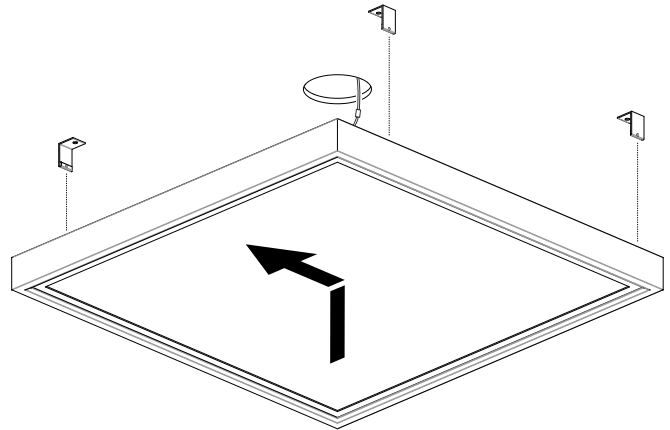

4. Lift frame up towards the ceiling, plug in power supply then locate frame on surface mount hangers and slide across

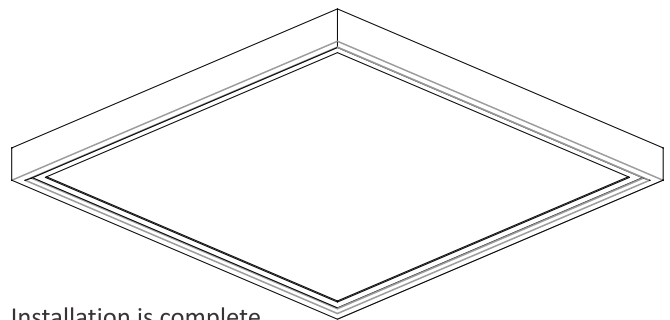

6. Installation is complete.

NOTE: For applications where the frame is required to be suspended by wire cables, slide in supplied hanger from centre slot of the frame and secure with grub screw. Hangers can then be used with wire cable to suspend the frame.

