

INSTALLATION GUIDE

RECESSED with QUICK-FIT SPRING CLIPS

CODE: LLF0312R

To suit LED Ceiling Panels

Panel size: 1195mm x 295mm

Frame size: 1259mm x 359mm

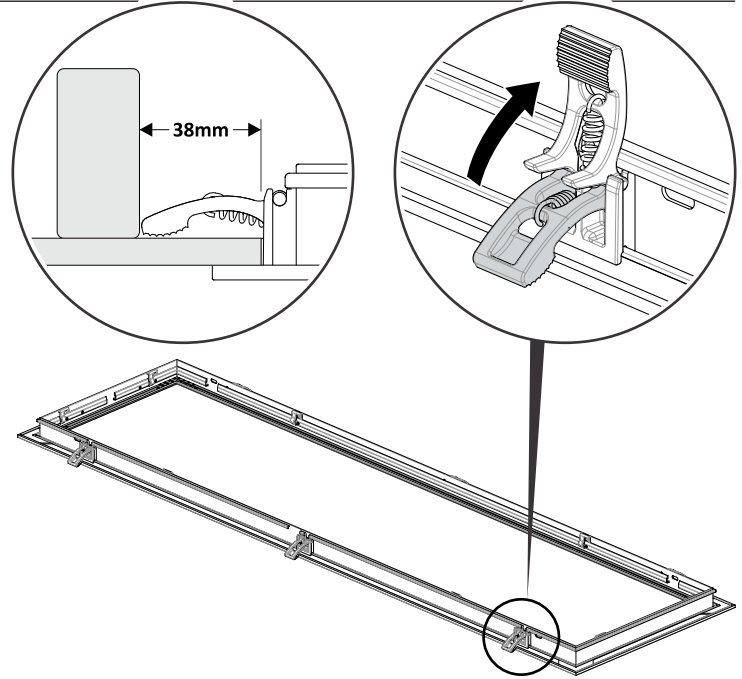
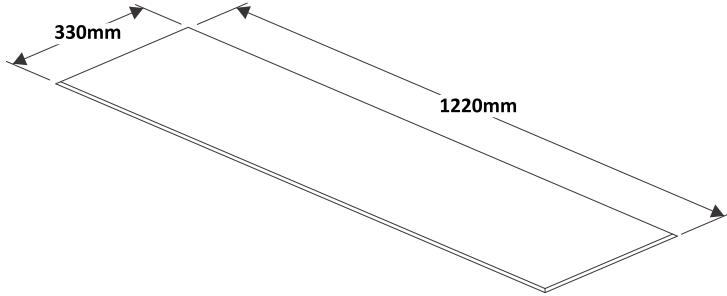

1. Neatly cut hole in gyprock ceiling.

2. Pull back each of the spring clips. Ensure there is clearance around the hole in the gyprock for the clips to engage.

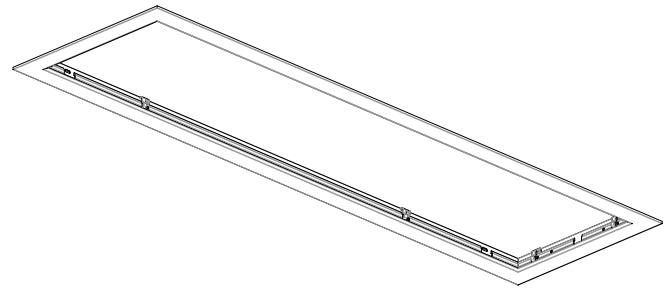
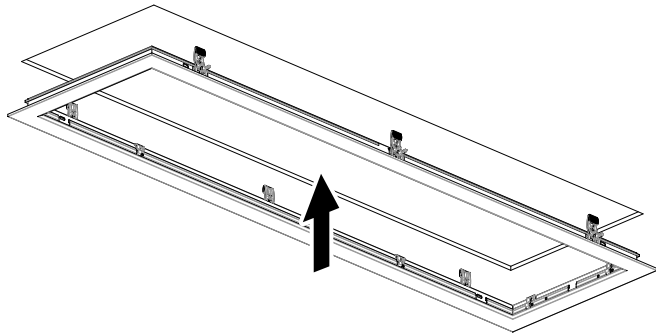

3. Carefully push frame up into hole - the spring clips will automatically engage.

4. Check frame is square and secure in ceiling.

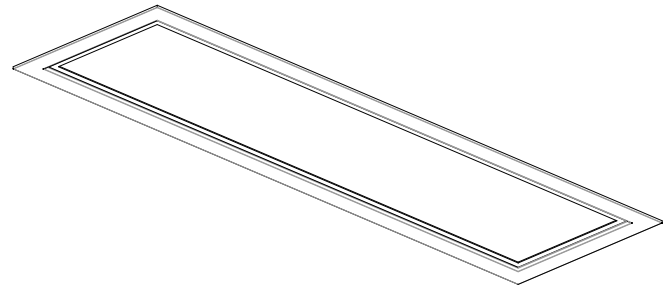
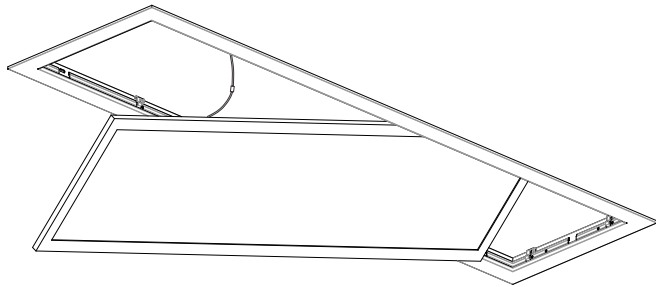

5. Angle LED light panel into frame and plug in power supply.

6. Lower LED light panel onto outer edges of frame, ensuring a secure fit.

NOTE: For applications where the frame is required to be secured by wire cables, slide in supplied hanger from centre slot of the frame and secure with grub screw. Hangers can then be used with wire cable to secure frame.

